

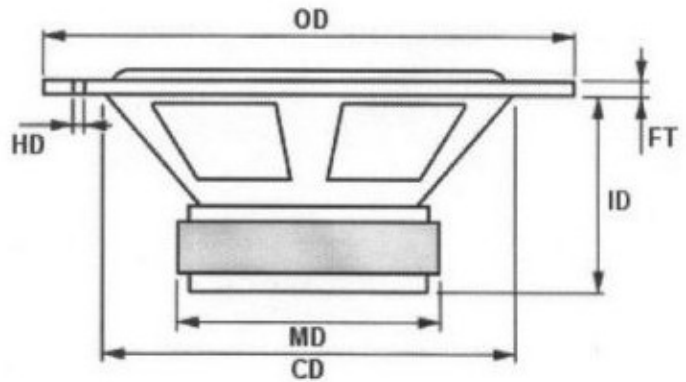

PL18W009-04

Nominal impedance [ohm]	4
Voice coil resistance [ohm]	3.0
Nominal power [W]	100
Short term max power [W]	400
Long term max power [W]	300
Operating power [W]	10
Sensitivity [dB]	89
Frequency range [Hz]	40-4000
Free air resonance [Hz]	37
Voice coil diameter [mm]	40
Voice coil height [mm]	14
Air gap height [mm]	6
Voice coil inductance [mH]	0.56
Eff. diaphragm Area [cm ²]	132
Moving mass [g]	18.5
Magnet weight [g]/[oz]	700/24.7
Force factor [Bl]	6.3
VAS [l]	25
Qms	2.53
Qes	0.33
Qts	0.29



OD: 180 mm	CD: 145 mm
FT: 5 mm	ID: -
MD: -	HD: -

