

AL 200 - 8 Ohm

Art. No. 1281



20 cm (8") High-End-Tieftöner mit steifer Aluminium-Membran, stabilem Aludruckgusskorb und elastischer Gummisicke. Geringste mechanische und elektrische Verluste durch Polkernventilierung, hinterlüftete Zentrierung und Kapton-Schwingspulenträger. Hohe Impulsdynamik durch leichte Alumembran.

Hervorragend geeignet in 2- und 3-Wege-Kombinationen und als Tiefmitteltontreiber in 4-Wege-High-End-Systemen.

20 cm (8") High-End woofer with stiff aluminium cone, solid aluminium die-cast basket and elastic rubber surround. Extremely low mechanical and electrical losses due to vented pole plate, vented damper and capton voice coil carrier. Fast pulse response due to light weight aluminium cone.

Suitable for 2- and 3-way high end combinations and as low-midrange driver in 4-way high end systems.

Gehäuseempfehlungen / Recommended cabinets

Volumen/Prinzip	BR-Rohr	f_b
30 l/Bassreflex	BR 25.50	40 Hz
50 l/Bassreflex	BR 25.50	31 Hz
70 l/Bassreflex	BR 25.50	27 Hz

Volume/Principle	BR-Channel	f_b
30 l/bass reflex	BR 25.50	40 Hz
50 l/bass reflex	BR 25.50	31 Hz
70 l/bass reflex	BR 25.50	27 Hz

01.10.2015

AL 200 - 8 Ohm

Art. No. 1281

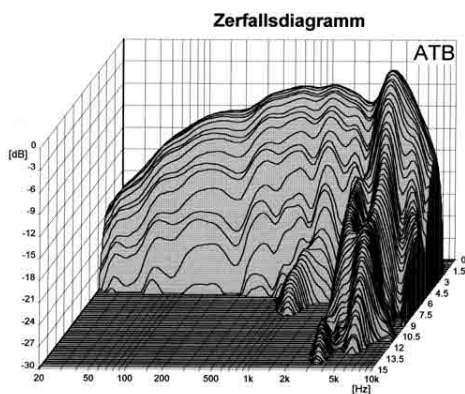
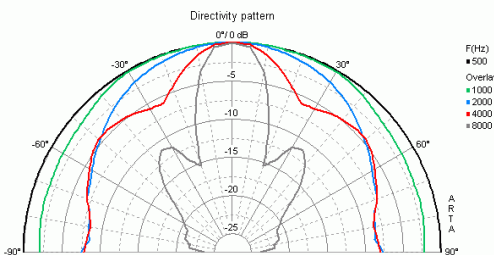
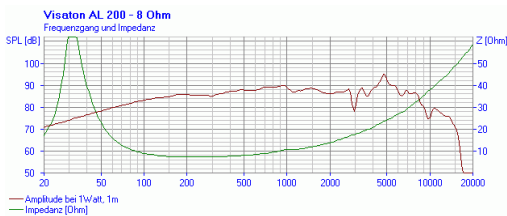
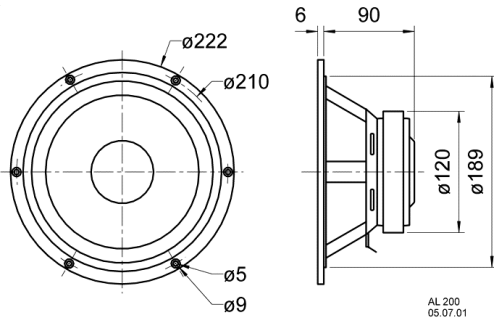

Technische Daten / Technical data

Nennbelastbarkeit Rated power	120 W
Musikbelastbarkeit Maximum power	180 W
Nennimpedanz Z Nominal impedance Z	8 Ohm
Übertragungsbereich Frequency response	fu-9000 Hz
(fu: untere Grenzfrequenz abhängig vom Gehäuse) (fu: Lower cut-off frequency depending on cabinet)	.
Mittlerer Schalldruckpegel Mean sound pressure level	88 dB (1 W/1 m)
Abstrahlwinkel (-6 dB) Opening angle (-6 dB)	122°/4000 Hz
Grenzauslenkung Excursion limit	+/-10 mm
Resonanzfrequenz fs Resonance frequency fs	32 Hz
Magnetische Induktion Magnetic induction	1,3 T
Magnetischer Fluss Magnetic flux	930 μ Wb
Obere Polplattenhöhe Height of front pole-plate	6 mm
Schwingspulendurchmesser Voice coil diameter	38 mm
Wickelhöhe Height of winding	20 mm
Schallwandöffnung Cutout diameter	190 mm
Gewicht netto Net weight	2,5 kg
Gleichstromwiderstand Rdc D.C. resistance Rdc	6,6 Ohm
Mechanischer Q-Faktor Qms Mechanical Q factor Qms	3,73
Elektrischer Q-Faktor Qes Electrical Q factor Qes	0,39
Gesamt-Q-Faktor Qts Total Q factor Qts	0,35

01.10.2015

Äquivalentes Luftnachgiebigkeitsvolumen Vas Equivalent volume Vas	77 l
Effektive Membranfläche Sd Effective piston area Sd	216 cm ²
Dynamische bewegte Masse Mms Dynamically moved mass Mms	21 g
Antriebsfaktor Bxl Force factor Bxl	8,8 Tm
Schwingspuleninduktivität L Inductance of the voice coil L	1,2 mH